



EASY CONNECT® INSTALLATION INSTRUCTIONS

IVL584A01/02
11/14

QUESTIONS OR CONCERNS CONTACT CANARM AT:
1-800-265-1833 (English) • 1-800-567-2513 (French)
Monday through Friday 8:00 AM to 5:00 PM E.S.T.



INSTRUCTIONS PERTAINING TO RISK OF FIRE OR INJURY TO PERSONS
READ ALL INSTRUCTIONS

**IMPORTANT SAFETY
INSTRUCTIONS**
SAVE THESE INSTRUCTIONS

SAFETY PRECAUTIONS:

1. TURN OFF ELECTRICAL POWER BEFORE STARTING INSTALLATION OF LIGHT FIXTURE.
2. THIS PRODUCT MUST BE INSTALLED IN ACCORDANCE WITH THE APPLICABLE INSTALLATION CODE BY A PERSON FAMILIAR WITH THE CONSTRUCTION AND OPERATION OF THE PRODUCT AND THE HAZARDS INVOLVED.

NOTE: Product May Not Look Exactly As Shown In Figures.

INSTALL EASY CONNECT MOUNTING BRACKET:

STEP 1

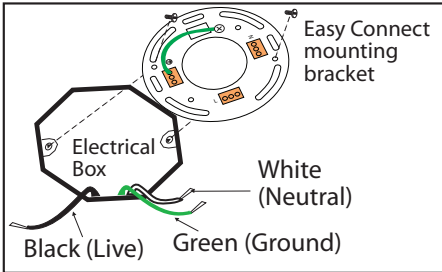

Attach easy connect mounting bracket to electrical box with electrical box screws (not included).

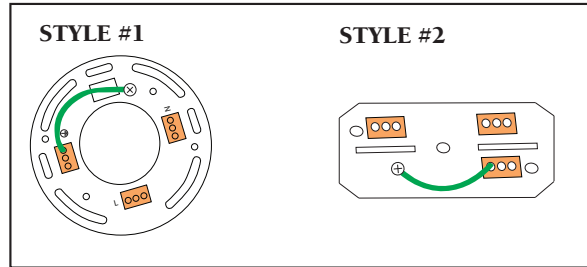

CONNECT HOUSE WIRES

STEP 2 - Option 1

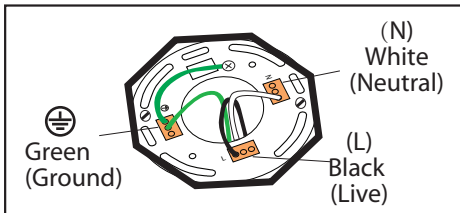

Connect (push) electrical wires from electric box (house wiring) into correct inserts. Black (Live), White (Neutral), Green (Ground)

Option 2 - MULTIPLE ELECTRICAL BOX WIRES

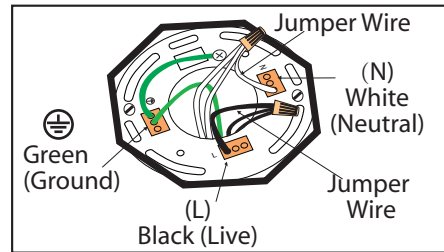

For multiple black (live) & white (neutral) wires joined in the electrical box (house wiring), attach a single "black" and "white" Jumper Wire before connecting. Strip 7mm from a 6" Jumper Wires (AWG 12-24) supplied. Then connect (push) wires into correct inserts.

CONNECT LIGHT FIXTURE

STEP 3

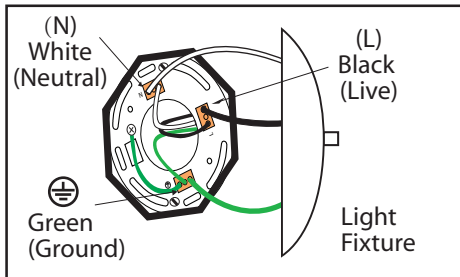

Connect (push) electrical wires from fixture into correct inserts. Black (live), White (neutral), Green (ground)

STEP 4

STYLE#1

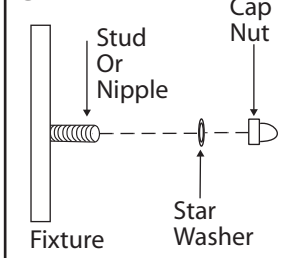

STYLE#1- Tuck electrical wires into outlet box and position fixture over studs or nipple on mounting bracket assembly. Secure fixture in place with star washer(s) and cap nut(s).
Note: If required, assemble body and spread the arms of the fixture out evenly.

STYLE#2

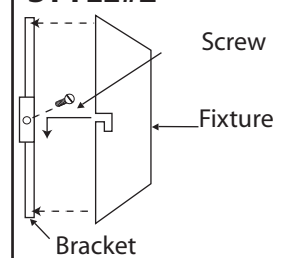

STYLE #2 - Insert one screw into the mounting bracket - do not tighten yet. Tuck electrical wires into outlet box and position fixture over the mounting bracket. Line up the screw in the bracket to the "7" hole on the fixture. Slide fixture to secure in place. Insert remaining screw. Tighten both screws to secure.

STEP 5 - Optional for some models (Note: Refer to the style of assembly that matches the style of your fixture.)

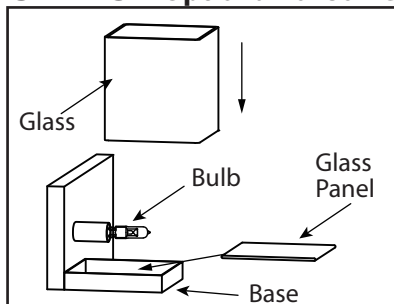

Insert the glass panel into the base. Install the specified bulb type and wattage (not included). Slide the glass down.